

Filtration

FUME EXTRACTION SOLUTIONS

+ LOW NOISE

+ LOW ENERGY CONSUMPTION

+ LARGE FILTER SURFACE FOR LONGER FILTER LIFETIME



Volume extraction

More suitable for applications involving, for example hand soldering, solder baths, hot-air soldering, microsoldering as well as gluing and cleaning work. Weller offers various mobile systems that purify the air for up to 8 workstations.

- Large areas can be covered
- Low maintenance
- For 1 to up to 8 work places
- Extraction cabinets
- Remote control



Tip extraction

Weller FE (fume extraction) soldering irons have a smoke tube integrated into the handle. When soldering, the tube is positioned directly above the tip and collects any fumes produced. Fume extraction attachments can be retrofitted to non-fume extraction Weller soldering irons.

- Low investment per workstation
- Contaminants extraction right at the source
- Up to 20 soldering points with one system (max. 200 m apart)
- Ergonomic with easy access to workpiece
- Minimal air movement



MOBILE



**QUICK & EASY
INSTALLATION**



Filtration

Filtration

222 - 286

Volume fume extraction	226
Exhaust hood	246
Easy-Click 60 Extraction Arms	249
Accessories for extraction arms	257
Accessories Volume Extraction	258
Tip extraction	264
Laser extraction	274
Accessories	277
Spare Filters	278
Compact filters MG 140	284
Replacement filters for discontinued MG filter systems	286



Laser extraction

The Weller Laser Line Series offers mobile fume extraction for all kinds of applications. All systems can be retrofitted with special filters for use in cleanrooms or inkjet printers.

- > Automatic constant flow control (CFC)
- > Interface via USB, RS 232 and optional relay outputs
- > Low-maintenance, brushless turbines
- > Acoustic and visual filter change alarm
- > Individually upgradable with special filters
- > Up to three separate filter components - ensuring low operating costs
- > Thermally recycable main filter housing

ZERO SMOG[®] and LASERLINE fume extraction solutions

WE CARE FOR YOUR ENVIRONMENT.

Why fume extraction?

Many work environments today, including soldering and adhesives applications, create particles and gases that can be harmful to the work place and the environment. To protect the operator, it is important to use an extraction system that is able to separate these particles and gases and then re-circulates the cleaned air back into the work place.

It is important to use the correct safety equipment to remove these hazardous substances. Inhaling fine particles is more dangerous than big particles that get caught more easily because they can block the alveoli in the lungs.



Why fume extraction?
See the video on
www.youtube.com/wellersoldering

Fine particles – A health hazard!

Protect your health and the health of your employees!

Particles and gases are hazardous to health. Fine particles can get into the lungs and cause allergies, asthma or cancer.



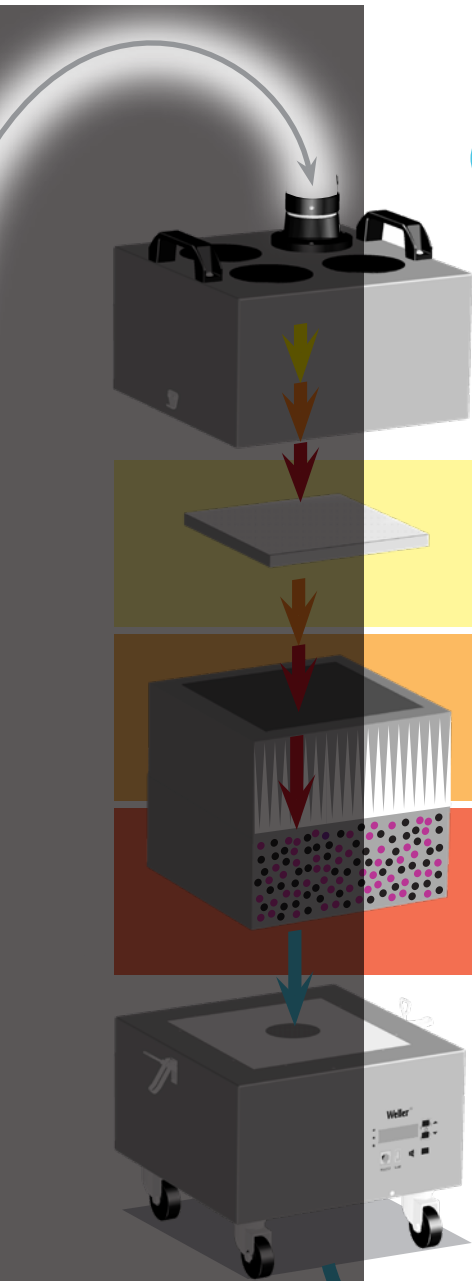

+ SEPARATE FILTERS
LESS WEAR

Up to four filters of different permeability separate out particles and gases that are hazardous to health.

Fine dust filter
M5 / F7

Particle filter
E12 / H13

Wide band
gas filter



 Fibers, pollen 10 µm
Bacteria, pigments 5 µm

 Smog
Asbestos dust > 1 µm
Viruses > 0.5 µm

 Gas

FINE DUST ACCUMULATION IN THE HUMAN BODY

- The smaller particles are, the deeper they penetrate into the respiratory system
- The deeper particles penetrate, the higher the health risks are
- The smallest particles travel via alveoli into the bloodstream

End product – clean air –
is re-circulated into
the workplace.

+ SAVES ENERGY
AND REDUCES
ENERGY COSTS



BEFORE
New filter

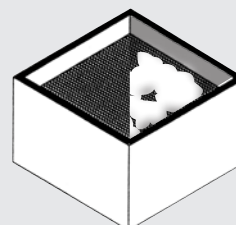

AFTER
90 minutes
soldering with
leadfree solder wire



Volume fume extraction

Weller systems are specifically designed for continuous operation in industrial environments. Care and attention at the design stage plus careful component choice and a high quality manufacturing process have given Weller extraction systems a world wide reputation for reliability and longevity.



SELECTION GUIDE

based on particle- and gas filter capacity

Application	Standard systems			Systems with high gas filter volume		Central systems with automatic flow control	
	Zero Smog EL	Zero Smog TL	MG 130	MG 100S	MG 140	Zero Smog 4V	Zero Smog 6V
Hand soldering	✓✓	✓✓	✓✓	✓✓✓	✓✓✓	✓✓✓	✓✓✓
Heavy duty fume applications (solder bath, selective wave)	✓	✓	✓	✓	✓✓	✓✓	✓✓✓
Soldering, gluing, cleaning, filling	✓	✓	✓✓	✓✓✓	✓✓✓	✓✓	✓✓✓
Gluing, Cleaning, Filling	✓	✓	✓✓	✓✓✓	✓✓✓	✓✓✓	✓✓✓
Finedust	✓✓	✓✓	✓✓	✓	✓✓✓	✓✓	✓✓✓
MEK (Methyl Ethyl Keton)			✓	✓✓✓	✓✓✓	✓	✓
VOC (Volatile Organic Compounds)			✓	✓✓✓	✓✓✓	✓	✓✓✓
Cleanroom					✓✓✓		



Zero Smog EL 230V F/G

Fume extraction unit



Order No. FT91 01 069 9N

- Fume extraction unit for 1 to 2 workplaces.
- Fine dust pre-filter M5 that can be separately changed, without having to change main filter
- Granular activated carbon filter for effective gas filtering
- Portable fume extraction unit, for placement under or next to the bench-top.
- Easy filter change.



TECHNICAL DATA

Max. capacity	1–2 workstations
Dimensions L x W x H (Inches)	13.19 x 14.17 x 17.52
Dimensions L x W x H (mm)	335 x 360 x 445
Weight (approx.) in kg	8.6
Voltage	220-240 V (50/60 Hz)
Power	120 VA
Noise level (distance 1 m) dB(A)	< 53
Max. blower vacuum (Pa)	2500
Capacity m ³ /h	150
Pre-filter	Pre-filter mat class M5
Compact filter	Particle filter H13, and granular activated carbon filter

Volume extraction

Tip Extraction

Laser Extraction

Accessories Volume extraction

Spare filter



Volume fume extraction

Zero Smog EL Kit 1

Fume extraction unit with flexible arm and funnel nozzle

120 VA
WX compatible
TRACEability Weller qualified
WT compatible

LOW SOUND LEVEL < 53 db(A)

Order No. FT91 01 269 9N

- Fume extraction unit for 1 to 2 workspaces.
- Fine dust pre-filter M5 that can be separately changed, without having to change main filter
- Granular activated carbon filter for effective gas filtering
- Portable fume extraction unit, for placement under or next to the bench-top.
- Easy filter change.

TECHNICAL DATA

Max. capacity	1–2 workstations
Dimensions L x W x H (Inches)	13.19 x 14.17 x 17.52
Dimensions L x W x H (mm)	335 x 360 x 445
Weight (approx.) in kg	8.6
Voltage	220-240 V (50/60 Hz)
Power	120 VA
Noise level (distance 1 m) dB(A)	< 53
Max. blower vacuum (Pa)	2500
Capacity m ³ /h	150
Pre-filter	Pre-filter mat class M5
Compact filter	Particle filter H13, Active carbon filter



Scope of supply	Order No.	Model	Description
		Zero Smog EL Unit	Zero Smog EL Unit
	0F15	0F15 Flexible extraction arm	Extraction arm, flexible, Ø 60 mm for sloped and funnel nozzles, length 1,5 m
	ALFA	ALFA Funnel Nozzle	Easy-Click 60 Funnel nozzle, for flexible and stativ extraction arm, width 230 mm, height 100 mm. To be mounted on an aluminium extraction arm without flexible hose, adapter Z is needed. See extraction arms accessories.
	T005 87 628 46	Fixing clamp	Fixing clamp Ø 63 mm, 1 piece, for fixing Easy-Click 60, 60 mm extraction arms



Zero Smog TL

Fume extraction unit Zero Smog TL



Order No. FT91 01 369 9N

- Low noise levels
- Automated filter change notification system
- Easily operated and easy filter replacement
- Longer service life due to exceptionally large filter surface
- For connection to a WX / WT station a WT Hub is needed

TECHNICAL DATA

Max. capacity	1–2 workstations
Dimensions L x W x H (Inches)	13.19 x 12.9 x 17.52
Dimensions L x W x H (mm)	335 x 330 x 445
Weight (approx.) in kg	9
Voltage	220-240 V (50/60 Hz)
Power	120 W
Noise level (distance 1 m) dB(A)	<50
Max. blower vacuum (Pa)	3.000
Capacity m ³ /h	190
Pre-filter	Fine dust prefilter F7
Compact filter	Particle filter H13 and granular activated carbon filter



Volume extraction

Tip Extraction

Laser Extraction

Accessories Volume extraction

Spare filter



Volume fume extraction

Zero Smog TL Kit 1 FN

Fume extraction unit with flexible extraction arm, extraction hose, stop valve with bench mounting brackets, remote switch and funnel nozzle

120 W **WX** compatible **TRACEability** qualified **WT** compatible
 LOW SOUND LEVEL < 50 db (A)

Order No. FT91 01 569 9N



Scope of supply	Order No.	Model	Description
	0F10	0F10 flexible Extraction arm	Easy-Click 60 flexible Extraction arm, Ø 60 mm for sloped and funnel nozzles, length 1 m
	700-3051-ESD	Extraction hose 3 meter	Easy-Click 60 Extraction hose Ø 60 mm, length: 3 meter
	ALFA	ALFA Funnel Nozzle	Easy-Click 60 Funnel nozzle, for flexible and stativ extraction arm, width 230 mm, height 100 mm. To be mounted on an aluminium extraction arm without flexible hose, adapter Z is needed. See extraction arms accessories.
	FT910 00 033	On-/Off-Switch	ZSRS Zero Smog Remote Switch
	FT910 13 699 N	Zero Smog TL	Fume extraction unit Zero Smog TL

Zero Smog TL Kit 2 FN

Fume extraction unit with 2 flexible extraction arms, 2 fixing clamps for the arms, a remote switch and 2 funnel nozzles

120 W **WX** compatible **TRACEability** qualified **WT** compatible
 LOW SOUND LEVEL < 50 db (A)

Order No. FT91 01 769 9N



Scope of supply	Order No.	Model	Description
	0F15	0F15 Flexible extraction arm	Extraction arm, flexible, Ø 60 mm for sloped and funnel nozzles, length 1,5 m
	ALFA	ALFA Funnel Nozzle	Easy-Click 60 Funnel nozzle, for flexible and stativ extraction arm, width 230 mm, height 100 mm. To be mounted on an aluminium extraction arm without flexible hose, adapter Z is needed. See extraction arms accessories.
	FT910 00 033	On-/Off-Switch	ZSRS Zero Smog Remote Switch
	FT910 13 699 N	Zero Smog TL	Fume extraction unit Zero Smog TL
	T005 87 628 46	Fixing clamp	Fixing clamp Ø 63 mm, 1 piece, for fixing Easy-Click 60, 60 mm extraction arms



Zero Smog TL Kit 2 SN

Fume extraction unit with 2 flexible extraction arms, 2 fixing clamps for the arms, a remote switch and 2 sloped nozzles

120 W

WX
compatibleTRACEability
qualifiedWT
compatibleLOW
SOUND
LEVEL  < 50 db (A)

Order No. FT91 01 669 9N



Scope of supply

Order No.	Model	Description
0F15	0F15 Flexible extraction arm	Extraction arm, flexible, Ø 60 mm for sloped and funnel nozzles, length 1,5 m
FT-NL	FT-NL Sloped nozzle	Easy-Click 60 metal nozzle Ø 60 mm, length 130 mm.
FT910 00 033	On-/Off-Switch	ZSRS Zero Smog Remote Switch
FT910 13 699 N	Zero Smog TL	Fume extraction unit Zero Smog TL
T005 87 628 46	Fixing clamp	Fixing clamp Ø 63 mm, 1 piece, for fixing Easy-Click 60, 60 mm extraction arms

Zero Smog TL with Gas Filter

Zero Smog TL fume extraction unit with Gas Filter

120 W

WX
compatibleTRACEability
qualifiedWT
compatibleLOW
SOUND
LEVEL  < 50 db (A)

Order No. FT91 01 469 9N



Scope of supply

Order No.	Model	Description
T005 87 359 38	Fine dust filter F7 WFE 2S, Zero Smog 4V	Fine dust filter F7 for WFE 2S, Zero Smog 4V

Volume extraction

Tip Extraction

Laser Extraction

Accessories Volume extraction

Spare filter



Volume fume extraction

MG 130

Fume extraction unit MG 130

100 W

LOW SOUND LEVEL  < 52 db(A)



Order No. 130-10 00- ESDN

- Unit purifies air up to 2 workplaces
- 100–240 power supply for global use
- Filter alarm and 3 steps speed control
- Small foot print design
- The fume extraction unit MG 130 is easy to install and operate. Is supplied complete ready to place close to the workbench.



TECHNICAL DATA

Max. capacity	1-2 workstations
Dimensions L x W x H (Inches)	18,11 x 8,26 x 19,68
Dimensions L x W x H (mm)	460 x 210 x 500
Weight (approx.) in kg	11
Voltage	100 - 240 V, 50/60 Hz
Power	100 W
Noise level (distance 1 m) dB(A)	< 52
Max. blower vacuum (Pa)	2.300
Capacity m ³ /h	140
Pre-filter	Pre filter mat class F7
Compact filter	Particle filter H13, Wide band gas filter (50 % Active carbon + 50 % Chemisorb)
ESD-safe	✓

Scope of supply	Order No.	Model	Description
		MG 130 Unit	MG 130 Unit
	130-2000-ESDN	Compact filter MG 130	Particle filter H13 and wide band gas filter, Standard
	130-2010	Fine dust filter F7 MG 130	Fine dust filter F7 for MG 130



MG 130 Kit Nozzle

Fume extraction unit MG 130 mit Kit Nozzle

100 W

LOW SOUND LEVEL



< 52 db(A)



Order No. 130-10 55- ESDN



Scope of supply

Order No.	Model	Description
MG 130 Unit	MG 130 Unit	MG 130 Unit
2 x 0F10	0F10 flexible Extraction arm	Easy-Click 60 flexible Extraction arm, Ø 60 mm for sloped and funnel nozzles, length 1 m
130-2000-ESDN	Compact filter MG 130	Particle filter H13 and wide band gas filter, Standard
130-2010	Fine dust filter F7 MG 130	Fine dust filter F7 for MG 130
2 x FT-NL	FT-NL Sloped nozzle	Easy-Click 60 metal nozzle Ø 60 mm, length 130 mm.

MG 130 Kit Funnel

Fume extraction unit MG 130 with Kit Funnel

100 W

LOW SOUND LEVEL



< 52 db(A)



Order No. FT91 00 010 3N



Scope of supply

Order No.	Model	Description
MG 130 Unit	MG 130 Unit	MG 130 Unit
2 x 0F10	0F10 flexible Extraction arm	Easy-Click 60 flexible Extraction arm, Ø 60 mm for sloped and funnel nozzles, length 1 m
2 x ALFA	ALFA Funnel Nozzle	Easy-Click 60 Funnel nozzle, for flexible and stativ extraction arm, width 230 mm, height 100 mm. To be mounted on an aluminium extraction arm without flexible hose, adapter Z is needed. See extraction arms accessories.

Volume extraction

Tip Extraction

Laser Extraction

Accessories Volume extraction

Spare filter



Volume fume extraction

MG 100S

Fume extraction unit MG 100S

100 W

LOW SOUND LEVEL < 52 db(A)



Order No. 100-10 00- ESDN

- Unit purifies air at up to 2 workplaces
- High Gasfilter volume
- Electronic filter control with filter alarm
- Variable speed setting
- Minimized foot print



TECHNICAL DATA

Max. capacity	1-2 workstations
Dimensions L x W x H (Inches)	18.11 x 8.26 x 24.15
Dimensions L x W x H (mm)	460 x 210 x 610
Weight (approx.) in kg	15
Voltage	110 - 240 V, 50/60 Hz
Power	100 W
Noise level (distance 1 m) dB(A)	< 52
Max. blower vacuum (Pa)	2.300
Capacity m ³ /h	140
Pre-filter	-
Compact filter	Particle filter H13, Wide band gas filter (50 % Active carbon + 50 % Chemisorb)
ESD-safe	✓

Scope of supply	Order No.	Model	Description
		MG 100S Unit	MG 100S Fume Extraction Unit
	100-2000-ESDN	Compact filter MG 100S Standard	Particle filter H13 and wide band gas filter, Standard



MG 100S Kit 1

Fume extraction unit MG 100S with Kit 2 Funnel

100 W

 LOW SOUND LEVEL  < 52 db(A)

Order No. 100-10 56- ESDN



Scope of supply	Order No.	Model	Description
		MG 100S Unit	MG 100S Fume Extraction Unit
	100-2000-ESDN	Compact filter MG 100S Standard	Particle filter H13 and wide band gas filter, Standard
	T005 36 571 99N	Kit 1 WF Funnel Nozzle	Easy-Click 60 extraction arm, flexible with funnel nozzle and stop valve

MG 100S Kit 2

Fume extraction unit MG 100S with Kit 2 Funnel

100 W

 LOW SOUND LEVEL  < 52 db(A)

Order No. 100-10 55- ESDN



Scope of supply	Order No.	Model	Description
		MG 100S Unit	MG 100S Fume Extraction Unit
2 x	0F15	0F15 Flexible extraction arm	Extraction arm, flexible, Ø 60 mm for sloped and funnel nozzles, length 1,5 m
	100-2000-ESDN	Compact filter MG 100S Standard	Particle filter H13 and wide band gas filter, Standard
2 x	ALFA	ALFA Funnel Nozzle	Easy-Click 60 Funnel nozzle, for flexible and stativ extraction arm, width 230 mm, height 100 mm. To be mounted on an aluminium extraction arm without flexible hose, adapter Z is needed. See extraction arms accessories.



Volume fume extraction

MG 100S Kit 3

Fume extraction unit MG 100S with Kit 3

100 W LOW SOUND LEVEL  < 52 db (A) 

Order No. 100-10 32- ESDN



Scope of supply	Order No.	Model	Description
		MG 100S Unit	MG 100S Fume Extraction Unit
	100-2000-ESDN	Compact filter MG 100S Standard	Particle filter H13 and wide band gas filter, Standard
	3-0F15	3-0F15 Flexible extraction arm	Easy- Click 60 Flexible extraction arm, Ø 32 mm, length 1,5 m



MG 140

Fume extraction unit MG 140

100 W

LOW SOUND LEVEL

< 50 dB(A)

Order No. 145-10 00- ESDN

- Unit purifies air at up to 2 workplaces
- High Gasfilter volume
- Electronic filter control with alarm function
- Switch power supply 100 - 240 V
- 4 wheels for easy movement



TECHNICAL DATA

Max. capacity	2 workstations
Dimensions L x W x H (Inches)	13.77 x 13.18 x 25.78
Dimensions L x W x H (mm)	350 x 335 x 655
Weight (approx.) in kg	18
Voltage	110 - 240 V, 50/60 Hz
Power	100 W
Noise level (distance 1 m) dB(A)	< 50
Max. blower vacuum (Pa)	2.300
Capacity m ³ /h	140
Pre-filter	Pre filter mat class F7
Compact filter	Particle filter H13, Wide band gas filter (50 % Active carbon + 50 % Chemisorb)
ESD-safe	✓

Scope of supply

Order No.	Model	Description
	MG 140 Unit	MG 140 Fume Extraction Unit
145-2000-ESDN	Compact filter MG 140	Particle filter H13 and wide band gas filter, Standard
145-4000	Pre-filter MG 140	Pre-filter for MG 140 / F8 (2 pieces)

Volume extraction

Tip Extraction

Laser Extraction

Accessories Volume extraction

Spare filter



Volume fume extraction

Zero Smog 4V

Fume extraction unit Zero Smog 4V



Order No. T005 36 606 99N

- Unit purifies air at up to 4 workplaces
- Constant Flow Control (CFC) guarantees automatical air flow regulation for each working place independent of the connected workplaces
- Electronic filter control with optical and acoustical filter alarm
- Efficiency test via USB port
- 4 wheels to allow easy movement of the unit



TECHNICAL DATA

Max. capacity	1–4 workstations
Dimensions L x W x H (Inches)	13.58 x 12.79 x 19.88
Dimensions L x W x H (mm)	345 x 325 x 505
Weight (approx.) in kg	19
Voltage	220-240 V (50/60 Hz)
Power	275 VA
Noise level (distance 1 m) dB(A)	< 48
Max. blower vacuum (Pa)	3.800
Capacity m ³ /h	230
Pre-filter	Pre filter mat class F7
Compact filter	Particle filter H13, Wide band gas filter (50 % Active carbon + 50 % Chemisorb)
ESD-safe	✓

Scope of supply	Order No.	Model	Description
		Zero Smog 4V Unit	Zero Smog 4V Unit
	T005 87 359 36N	Compact filter Zero Smog 4V, WFE 2S	Compact filter: Particle filter H13 and wide band gas filter (50% active carbon, 50% Chemisorb) for Zero Smog 4V, WFE 2S
	T005 87 359 38	Fine dust filter F7 WFE 2S, Zero Smog 4V	Fine dust filter F7 for WFE 2S, Zero Smog 4V
	T005 87 627 67N	Easy-Click 60 Hose connector straight	Easy-Click 60 Hose connector, straight for WFE 2S / WFE 4S, Zero Smog 4V / Zero Smog 6V and pre filter box



Zero Smog 4V Adhesive fume filter

Fume extraction unit Zero Smog 4V



Order No. T005 36 616 99N

- Unit purifies air at up to 4 workplaces
- Constant Flow Control (CFC) guarantees automatical air flow regulation for each working place independent of the connected workplaces
- Electronic filter control with optical and acoustical filter alarm
- Efficiency test via USB port
- 4 wheels to allow easy movement of the unit



Scope of supply	Order No.	Model	Description
		Zero Smog 4V Unit	Zero Smog 4V Unit

Volume extraction

Tip Extraction

Laser Extraction

Accessories Volume extraction

Spare filter



Volume fume extraction

Zero Smog 4V Kit 1 Nozzle

Fume extraction unit Zero Smog 4V with Kit 1 Nozzle

275 VA **WX** compatible **TRACEability** qualified **WT** compatible
 LOW SOUND LEVEL < 48 db (A)

Order No. T005 36 636 99N



Scope of supply	Order No.	Model	Description
		Zero Smog 4V Unit	Zero Smog 4V Unit
	T005 36 572 99N	Kit 1 Sloped Nozzle	Easy-Click 60 extraction arm with sloped nozzle and stop valve
	T005 87 359 36N	Compact filter Zero Smog 4V, WFE 2S	Compact filter: Particle filter H13 and wide band gas filter (50% active carbon, 50% Chemisorb) for Zero Smog 4V, WFE 2S
	T005 87 359 38	Fine dust filter F7 WFE 2S, Zero Smog 4V	Fine dust filter F7 for WFE 2S, Zero Smog 4V
	T005 87 627 67N	Easy-Click 60 Hose connector straight	Easy-Click 60 Hose connector, straight for WFE 2S / WFE 4S, Zero Smog 4V / Zero Smog 6V and pre filter box

Zero Smog 4V Kit 2 Nozzle

Fume extraction Zero Smog 4V with Kit 2 Nozzle

275 VA **WX** compatible **TRACEability** qualified **WT** compatible
 LOW SOUND LEVEL < 48 db (A)

Order No. T005 36 656 99N



Scope of supply	Order No.	Model	Description
		Zero Smog 4V Unit	Zero Smog 4V Unit
2 x	T005 36 572 99N	Kit 1 Sloped Nozzle	Easy-Click 60 extraction arm with sloped nozzle and stop valve
	T005 87 359 36N	Compact filter Zero Smog 4V, WFE 2S	Compact filter: Particle filter H13 and wide band gas filter (50% active carbon, 50% Chemisorb) for Zero Smog 4V, WFE 2S
	T005 87 359 38	Fine dust filter F7 WFE 2S, Zero Smog 4V	Fine dust filter F7 for WFE 2S, Zero Smog 4V
2 x	T005 87 627 67N	Easy-Click 60 Hose connector straight	Easy-Click 60 Hose connector, straight for WFE 2S / WFE 4S, Zero Smog 4V / Zero Smog 6V and pre filter box



Zero Smog 4V Kit 1 Funnel

Fume extraction Zero Smog 4V with Kit 1 Funnel



Order No. T005 36 626 99N



Scope of supply	Order No.	Model	Description
		Zero Smog 4V Unit	Zero Smog 4V Unit
	T005 36 571 99N	Kit 1 WF Funnel Nozzle	Easy-Click 60 extraction arm, flexible with funnel nozzle and stop valve
	T005 87 359 36N	Compact filter Zero Smog 4V, WFE 2S	Compact filter: Particle filter H13 and wide band gas filter (50% active carbon, 50% Chemisorb) for Zero Smog 4V, WFE 2S
	T005 87 359 38	Fine dust filter F7 WFE 2S, Zero Smog 4V	Fine dust filter F7 for WFE 2S, Zero Smog 4V
	T005 87 627 67N	Easy-Click 60 Hose connector straight	Easy-Click 60 Hose connector, straight for WFE 2S / WFE 4S, Zero Smog 4V / Zero Smog 6V and pre filter box

Zero Smog 4V Kit 2 Funnel

Fume extraction Zero Smog 4V with Kit 2 Funnel



Order No. T005 36 646 99N



Scope of supply	Order No.	Model	Description
		Zero Smog 4V Unit	Zero Smog 4V Unit
2 x	T005 36 571 99N	Kit 1 WF Funnel Nozzle	Easy-Click 60 extraction arm, flexible with funnel nozzle and stop valve
	T005 87 359 36N	Compact filter Zero Smog 4V, WFE 2S	Compact filter: Particle filter H13 and wide band gas filter (50% active carbon, 50% Chemisorb) for Zero Smog 4V, WFE 2S
	T005 87 359 38	Fine dust filter F7 WFE 2S, Zero Smog 4V	Fine dust filter F7 for WFE 2S, Zero Smog 4V
2 x	T005 87 627 67N	Easy-Click 60 Hose connector straight	Easy-Click 60 Hose connector, straight for WFE 2S / WFE 4S, Zero Smog 4V / Zero Smog 6V and pre filter box



Volume fume extraction

Zero Smog 6V

Fume extraction Zero Smog 6V



Order No. T005 36 666 99N

- Unit purifies air at up to 8 workplaces
- The Constant Flow Control (CFC) guarantees optimal air flow regulation for each working place independent of the connected workplaces
- Efficiency test via USB port
- Electronic filter control with optical and acoustical filter alarm
- 4 wheels to allow easy movement of the unit



TECHNICAL DATA

Max. capacity	1-8 workstations
Dimensions L x W x H (Inches)	18,11 x 18,11 x 26,18
Dimensions L x W x H (mm)	460 x 460 x 665
Weight (approx.) in kg	40
Voltage	230 V, 50/60 Hz (120 V, 60 Hz)
Power	460 VA
Noise level (distance 1 m) dB(A)	< 51
Max. blower vacuum (Pa)	3.000
Capacity m ³ /h	615
Pre-filter	Pre filter mat class F7
Compact filter	Particle filter H13, Wide band gas filter (50 % Active carbon / 50 % Chemisorb)
ESD-safe	✓

Scope of supply	Order No.	Model	Description
		Zero Smog 6V Unit	Zero Smog 6V Unit
	T005 87 358 36	Fine dust filter F7	Fine dust filter F7 for Zero Smog 20T, WFE 20D, WFE 4S, Zero Smog 6V, FC 800
	T005 87 358 38	Compact filter	Compact filter for WFE 20D, WFE 4S, Zero Smog 6V, Zero Smog 20T, FC 800
	T005 87 627 67N	Easy-Click 60 Hose connector straight	Easy-Click 60 Hose connector, straight for WFE 2S / WFE 4S, Zero Smog 4V / Zero Smog 6V and pre filter box



Zero Smog 6V with gas filter

Fume extraction Zero Smog 6V for adhesive fumes



Order No. T005 36 676 99N

- Unit purifies air at up to 8 workplaces
- The Constant Flow Control (CFC) guarantees optimal air flow regulation for each working place independent of the connected workplaces
- Efficiency test via USB port
- Electronic filter control with optical and acoustical filter alarm
- 4 wheels to allow easy movement of the unit



Scope of supply	Order No.	Model	Description
		Zero Smog 6V Unit	Zero Smog 6V Unit
	T005 87 358 35	Wide band gas filter	Wide band gas filter for Zero Smog 6V, WFE 4S
	T005 87 358 36	Fine dust filter F7	Fine dust filter F7 for Zero Smog 20T, WFE 20D, WFE 4S, Zero Smog 6V, FC 800
	T005 87 627 67N	Easy-Click 60 Hose connector straight	Easy-Click 60 Hose connector, straight for WFE 2S / WFE 4S, Zero Smog 4V / Zero Smog 6V and pre filter box
Accessories	Order No.	Model	Description
	T005 31 191 99	RS 232 Interface cable	Interface cable RS 232, 2 m (78.74 in) for remote control or monitoring by PC (type 1:1) T005 87 359 09
	T005 87 359 09N	Remote Control Zero Smog Units	Remote control for fume extraction units ZS 4V, ZS 6V, ZS 20T with filter status display

Volume extraction

Tip Extraction

Laser Extraction

Accessories Volume extraction

Spare filter



Volume fume extraction

CBC A 230 V 4 x Easy Click 60

Air curtain cabinet CBCA with unique ventilation concept

65 W

LOW SOUND LEVEL  < 49 db (A)



Order No. CBCA 11 2G0 4G65I2N

- 80 % low running cost against conventional extraction cabins. CBC-A needs only 200 m³/h. Conventional 1000 m³/h
- Mobile System for flexible use on a work bench or trolley.
- Large open front working area with no glass screen.
- Low noise level
- Cabinet interior fittings: Tube lighting (2 x 39 W), 230 V, 4 pcs. mains connector 230 V



CBC A 160mm hose connector for central ventilation

CBCA 160 mm hose connector for central ventilation

65 W

LOW SOUND LEVEL  < 49 db (A)



Order No. CBCA 11 2G0 2G65I2N

- 80 % low running cost against conventional extraction cabins. CBC-A needs only 200 m³/h. Conventional 1000 m³/h
- Mobile System for flexible use on a work bench or trolley.
- Large open front working area with no glass screen.
- Low noise level
- Cabinet interior fittings: Tube lighting (2 x 39 W), 230 V, 4 pcs. mains connector 230 V



Accessories

Order No.	Description
T005 36 666 99N	Fume extraction Zero Smog 6V
700-3051-ESD	Easy-Click 60 Extraction hose Ø 60 mm, length: 3 meter



WESDA 402 Exhaust cabinet 400 liter

Acryl Extraction Cabinet 400 Ltr.



Order No. FT91 00 002 1

- 4 lower shelf
- The ESD safe WESDA Acryl exhaust cabinets are designed to store components during the drying time after gluing or epoxy resin filling processes. The gas emissions are extracted by an extraction unit connected via an easy click 60 hose adapter at the back of the cabinet.
- The ESD safe WESDA Acryl exhaust cabinets are designed to store components during the drying time after gluing or epoxy resin filling processes. The gas emissions are extracted by an extraction unit connected via an easy click 60 hose adapter at the back of the cabinet.



Accessories	Order No.	Model	Description
	700-3041-ESD	Extraction hose 2 meter	Easy-Click 60 Extraction hose Ø 60 mm, length: 2 meter
	T005 36 616 99N	Zero Smog 4V Adhesive fume filter	Fume extraction unit Zero Smog 4V

WESDA 201 Exhaust cabinet 200 liter

Acryl Extraction Cabinaet 200 Ltr.



Order No. FT91 00 002 0

- 2 lower shelf
- The ESD safe WESDA 201 Acryl exhaust cabinets are designed to store components during the drying time after gluing or epoxy resin filling processes. The gas emissions are extracted by an extraction unit connected via an easy click 60 hose adapter at the back of the cabinet.



Accessories	Order No.	Model	Description
	700-3041-ESD	Extraction hose 2 meter	Easy-Click 60 Extraction hose Ø 60 mm, length: 2 meter
	T005 36 616 99N	Zero Smog 4V Adhesive fume filter	Fume extraction unit Zero Smog 4V



Exhaust hood

WEHT Exhaust hood for rising fumes

Extraction hood WEHT with Easy-Click 60 exhaust top connector

Order No. FT91000022N

- For applications where fumes spread rapidly due to a drafty work environment.
- The hood can enclose the source, enabling fumes to be captured before they contaminate the workplace
- The housing is PET and is NOT ESD safe
- Comes with 700-3051-ESD extraction hose Easy-Click 60 (60 mm diameter), 3 meters long
- Compatible with Weller Zero Smog 4V or Zero Smog 6V systems



Accessories	Order No.	Model	Description
	700-3051-ESD	Extraction hose 3 meter	Easy-Click 60 Extraction hose Ø 60 mm, length: 3 meter
	FT910 04 699	Zero Smog 2	Fume extraction unit Zero Smog 2

WEHB Exhaust hood for glueing / cleaning

WEHB Extraction Hood Bottom for gluing or cleaning applications

Order No. FT91000023N

- Bottom source extraction hood for gluing or cleaning applications where gases from solvents or glue, lighter than air have to be extracted from below
- Mobil use on a bench or trolley
- To guarantee sufficient extraction results an extraction unit with minimum 230 m³/h must be connected to the hood
- The workplace is covered with a punched stainless steel plate
- Comes with the 700-3051-ESD extraction hose Easy-Click 60 (60 mm diameter), 3 meters in length



Accessories	Order No.	Model	Description
	700-3051-ESD	Extraction hose 3 meter	Easy-Click 60 Extraction hose Ø 60 mm, length: 3 meter
	FT910 05 699 N	Zero Smog 2 Fume extraction unit for Adhesive fumes	Fume extraction unit Zero Smog 2



Zero Smog 4V Kit Extraction Hood

Set: Fume Extraction Zero Smog 4V and Extraction Hood WEHT with top extraction

275 VA

WX
compatible

TRACEability
Weller qualified

LOW SOUND LEVEL  48 db (A)

Order No. FT91 00 002 4N

- The Zero Smog 4V Kit Extraction Hood Top used for applications where fumes spread rapidly due to a drafty work environment. The hood can enclose the source, enabling fumes to be captured before they contaminate the workplace. To guarantee sufficient extraction results an extraction unit with minimum 230 m³/h must be connected to the hood.



Scope of supply	Order No.	Model	Description
	700-3051-ESD	Extraction hose 3 meter	Easy-Click 60 Extraction hose Ø 60 mm, length: 3 meter
	FT910 00 022 N	WEHT Exhaust hood for rising fumes	Extraction hood WEHT with Easy-Click 60 exhaust top connector
	T005 36 606 99N	Zero Smog 4V	Fume extraction unit Zero Smog 4V
Accessories	Order No.	Model	Description
	T005 31 191 99	RS 232 Interface cable	Interface cable RS 232, 2 m (78.74 in) for remote control or monitoring by PC (type 1:1) T005 87 359 09

Exhaust hood metal

Exhaust hood, metal



Order No. T005 87 358 45N

- 200 x 100 mm (7,87 x 3,93 Inch)
- Use with hot air soldering operations uses extraction hose 60
- Metal black
- Inclusive adapter T00 587 627 53



Accessories	Order No.	Model	Description
	T005 87 620 36	Extension hose 60	Extension hose, heavy construction, sold by metre (max. length 15 m)

Volume extraction

Tip Extraction

Laser Extraction

Accessories Volume extraction

Spare filter



Zero Smog 4V Kit with WEHB extraction hood

Fume extraction Zero Smog 4V with Extraction Hood WEHB, bottom extraction

275 VA **WX** **TRACEability**
compatible Weller qualified
LOW SOUND LEVEL **48 db (A)**

Order No. FT91 00 002 5N

- The Zero Smog 4V kit with WEHB Extraction Hood could be used for gluing or cleaning applications where gases from solvents or glue, lighter than air, have to be extracted from below. The work place is covered with a punched steel plate. To guarantee sufficient extraction results, an extraction unit with a minimum 230 m³/h must be connected to the hoods.



Scope of supply	Order No.	Model	Description
	700-3051-ESD	Extraction hose 3 meter	Easy-Click 60 Extraction hose Ø 60 mm, length: 3 meter
	FT910 00 023 N	WEHB Exhaust hood for glueing / cleaning	WEHB Extraction Hood Bottom for glueing or cleaning applications
	T005 36 616 99N	Zero Smog 4V Adhesive fume filter	Fume extraction unit Zero Smog 4V

Accessories	Order No.	Model	Description
	T005 31 191 99	RS 232 Interface cable	Interface cable RS 232, 2 m (78.74 in) for remote control or monitoring by PC (type 1:1) T005 87 359 09
	T005 87 359 09N	Remote Control Zero Smog Units	Remote control for fume extraction units ZS 4V, ZS 6V, ZS 20T with filter status display



Easy-Click 60 Extraction Arms

The Weller Easy Click 60 system is a flexible, easy-to-install connector system for quickly and safely putting together surface extraction systems as you want—without any tools*.

The ESD-safe Easy Click 60 modules provide a variety of connection solutions and are suitable for every application at the workstation. The individual elements can be combined with each other or expanded for individual requirements based on the modular principle.

In addition, thanks to the logical design, the elements can be quickly and flexibly adapted to modified production conditions.

*Except in the case of air intake ports



Kit 1 WF 32

Easy-Click 60 extraction arm with sloped nozzle, length 1 m, Ø 32 mm, stop valve.



Order No. T005 87 627 70N

Scope of supply	Order No.	Model	Description
	700-3051-ESD	Extraction hose 3 meter	Easy-Click 60 Extraction hose Ø 60 mm, length: 3 meter
	T005 36 574 99N	Easy-Click 60 Stop valve	Easy-Click 60 Stop valve for table connection of and flex arm and extraction hose including air flow valve and 2 bench mounting brackets.
	T005 36 580 99	WF 32 Extraction Arm 32 mm, with sloped nozzle	WF 32 ESD microscope extraction arm
	T005 87 628 34	Sloped Nozzle 31 mm	Sloped aluminium nozzle for 32 mm flex arms, Ø 31 mm, length 60 mm

Volume extraction

Tip Extraction

Laser Extraction

Accessories Volume extraction

Spare filter



Kit 1 WF Funnel Nozzle

Easy-Click 60 extraction arm, flexible with funnel nozzle and stop valve



Order No. T005 36 571 99N

Scope of supply	Order No.	Model	Description
	0F10	0F10 flexible Extraction arm	Easy-Click 60 flexible Extraction arm, Ø 60 mm for sloped and funnel nozzles, length 1 m
	700-3051-ESD	Extraction hose 3 meter	Easy-Click 60 Extraction hose Ø 60 mm, length: 3 meter
	ALFA	ALFA Funnel Nozzle	Easy-Click 60 Funnel nozzle, for flexible and stativ extraction arm, width 230 mm, height 100 mm. To be mounted on an aluminium extraction arm without flexible hose, adapter Z is needed. See extraction arms accessories.
	T005 36 574 99N	Easy-Click 60 Stop valve	Easy-Click 60 Stop valve for table connection of and flex arm and extraction hose including air flow valve and 2 bench mounting brackets.

Kit 1 Sloped Nozzle

Easy-Click 60 extraction arm with sloped nozzle and stop valve



Order No. T005 36 572 99N

Scope of supply	Order No.	Model	Description
	0F10	0F10 flexible Extraction arm	Easy-Click 60 flexible Extraction arm, Ø 60 mm for sloped and funnel nozzles, length 1 m
	700-3051-ESD	Extraction hose 3 meter	Easy-Click 60 Extraction hose Ø 60 mm, length: 3 meter
	FT-NL	FT-NL Sloped nozzle	Easy-Click 60 metal nozzle Ø 60 mm, length 130 mm.
	T005 36 574 99N	Easy-Click 60 Stop valve	Easy-Click 60 Stop valve for table connection of and flex arm and extraction hose including air flow valve and 2 bench mounting brackets.



Kit 1S WF Sloped Nozzle

Easy-Click 60 2 joint aluminium extraction arm with sloped and stop valve



Order No. T005 36 579 99N



Scope of supply	Order No.	Model	Description
	0F07	Easy-Click 60 Flexible extraction arm Ø 60 mm length 0,7 m	Easy-Click 60 flexible Extraction arm, Ø 60 mm for sloped and funnel nozzles, length 0,7 m, with connectors.
	700-3051-ESD	Extraction hose 3 meter	Easy-Click 60 Extraction hose Ø 60 mm, length: 3 meter
	FT-NL	FT-NL Sloped nozzle	Easy-Click 60 metal nozzle Ø 60 mm, length 130 mm.
	T005 36 598 99N	2 Joint Extraction Arm	Easy-Click 60 2 joint aluminium extraction arm with valve and ball joint bracket

Kit 1S WF Funnel Nozzle

Easy-Click 60 1 joint aluminium extraction arm with funnel nozzle and stop valve



Order No. T005 87 627 63N



Scope of supply	Order No.	Model	Description
	0F07	Easy-Click 60 Flexible extraction arm Ø 60 mm length 0,7 m	Easy-Click 60 flexible Extraction arm, Ø 60 mm for sloped and funnel nozzles, length 0,7 m, with connectors.
	700-3051-ESD	Extraction hose 3 meter	Easy-Click 60 Extraction hose Ø 60 mm, length: 3 meter
	ALFA	ALFA Funnel Nozzle	Easy-Click 60 Funnel nozzle, for flexible and stativ extraction arm, width 230 mm, height 100 mm. To be mounted on an aluminium extraction arm without flexible hose, adapter Z is needed. See extraction arms accessories.
	T005 87 627 47N	1 Joint Extraction Arm	Easy-Click 60 1 joint aluminium extraction arm with valve and bench mounting brackets

Volume extraction

Tip Extraction

Laser Extraction

Accessories Volume extraction

Spare filter



KIT 1 Extraction arm with ALFA funnel nozzle

KIT 1 Extraction arm (Ø 60 mm, length 1,5 m)
with an ALFA funnel nozzle and a fixing clamp

Order No. FT91 00 003 7N



Scope of supply	Order No.	Model	Description
	0F15	0F15 Flexible extraction arm	Extraction arm, flexible, Ø 60 mm for sloped and funnel nozzles, length 1,5 m
	ALFA	ALFA Funnel Nozzle	Easy-Click 60 Funnel nozzle, for flexible and stativ extraction arm, width 230 mm, height 100 mm. To be mounted on an aluminium extraction arm without flexible hose, adapter Z is needed. See extraction arms accessories.
	T005 87 628 46	Fixing clamp	Fixing clamp Ø 63 mm, 1 piece, for fixing Easy-Click 60, 60 mm extraction arms

Extraction Tripod

Easy-Click 60 1 joint extraction tripod



Order No. FT91 00 002 6N

- For volume extraction in higher work area like soldering in switch cabinets. Ready for mounting on Zero Smog 4 V. Measurements with extraction unit: High 1300 mm, Joint 213 mm





1 Joint Extraction Arm

Easy-Click 60 1 joint aluminium extraction arm with valve and bench mounting brackets



Order No. T005 87 627 47N



2 Joint Extraction Arm

Easy-Click 60 2 joint aluminium extraction arm with valve and ball joint bracket



Order No. T005 36 598 99N



Ball Joint Extraction Arm

Easy-Click 60 ball joint aluminium extraction arm with valve and ball joint bracket



Order No. FT-3 44 6N



Volume extraction

Tip Extraction

Laser Extraction

Accessories Volume extraction

Spare filter



1 Joint Double Extraction Arm

Easy-Click 60 1 joint double aluminium extraction arm with valve and bench mounting brackets



Order No. FT-4 40 2N



Extension Rotating Joint

Easy-Click 60 extension joint rotating



Order No. FT-3 41 7N

- 1 Joint Extension
- For all Easy-click aluminium extraction arms





Extension Rotating Joint Sloped Nozzle

Easy-Click 60 extension rotating joint



Order No. FT-3 47 5N

- 1 Joint Extension
- With length adjustable sloped 45° P nozzle for all Easy-click aluminium extraction arms

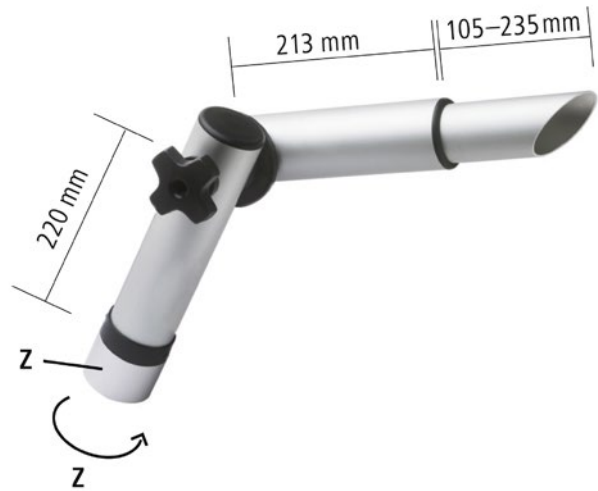

1 Joint Wall Mounting Arm

Easy-Click 60 1 joint aluminium extraction arm with valve



Order No. FT-3 47 0N



Volume extraction

Tip Extraction

Laser Extraction

Accessories Volume extraction

Spare filter



WF 32 Extraction Arm 32 mm, with sloped nozzle



- Flexible 1m long extraction arm, Ø 32 mm, with sloped 45° aluminium nozzle



Order No.	Description
T005 36 580 99	WF 32 ESD microscope extraction arm

Easy-Click Flexible Extraction Arms, Ø 32 mm



Order No.	Description
3-0F05	Easy-Click 60 Flexible Extraction arm, Ø 32 mm, length 0,5 m
3-0F07	Easy-Click 60 Flexible extraction arm, Ø 32 mm, length 0,7 Meter
3-0F15	Easy- Click 60 Flexible extraction arm, Ø 32 mm, length 1,5 m

Flexible Extraction Arms Ø 60 mm



Order No.	Description
0F05	Easy-Click 60 flexible Extraction arm, Ø 60 mm for sloped and funnel nozzles, length 0,5 m, with connectors.
0F07	Easy-Click 60 flexible Extraction arm, Ø 60 mm for sloped and funnel nozzles, length 0,7 m, with connectors.
0F10	Easy-Click 60 flexible Extraction arm, Ø 60 mm for sloped and funnel nozzles, length 1 m
0F15	Extraction arm, flexible, Ø 60 mm for sloped and funnel nozzles, length 1,5 m
0F20	Extraction arm, flexible, Ø 60 mm for sloped and funnel nozzles, length 2,0 m



Accessories for extraction arms

Extraction Arm Nozzles

	Order No.	Description
	ALFA	Easy-Click 60 Funnel nozzle, for flexible and static extraction arm, width 230 mm, height 100 mm. To be mounted on an aluminium extraction arm without flexible hose, adapter Z is needed. See extraction arms accessories.
	ALFA-T	Easy-Click 60 Funnel nozzle transparent
	FT-N	Easy-Click 60 metal sloped nozzle Ø 50 mm, length 130 mm.
	FT-NL	Easy-Click 60 metal nozzle Ø 60 mm, length 130 mm.
	FT-NS	Easy-Click 60 sloped metal nozzle for with grid Ø 50 mm, length 130 mm.
	FT-PN	Metal tube nozzle sloped for aluminium arms, Ø 50 mm
	T005 87 628 34	Sloped aluminium nozzle for 32 mm flex arms, Ø 31 mm, length 60 mm
	FT-U	Easy-Click 60 Funnel nozzle, for flexible and static extraction arms
	T005 87 358 45N	Exhaust hood, metal
	Z	Adapter to mount nozzles on aluminium arm with possibility to turn the nozzle (360°)

Volume extraction

Tip Extraction





Laser Extraction

Accessories Volume extraction

Spare filter



Accessories Volume Extraction

	Order No.	Description
	T005 87 628 65	Wire handle/brush extension 1000 mm
 	T005 87 627 67N	Easy-Click 60 Hose connector, straight for WFE 2S / WFE 4S, Zero Smog 4V / Zero Smog 6V and pre filter box
 	T005 87 627 69	Easy-Click 60 Hose connector, angle 90° for WFE 2S / WFE 4S, Zero Smog 4V / Zero Smog 6V and pre filter box







Extraction Hose



Order No.	Description
700-3040-ESD	Easy-Click 60 Extraction hose Ø 60 mm length: 1 meter
700-3041-ESD	Easy-Click 60 Extraction hose Ø 60 mm, length: 2 meter
700-3051-ESD	Easy-Click 60 Extraction hose Ø 60 mm, length: 3 meter
700-3053-ESD	Easy-Click 60 Extraction hose Ø 60 mm length: 5 meter



Easy-Click 60

	Order No.	Description
	T005 87 627 55	Easy-Click 60 Male adapter for hose extension, Ø 60 mm
	T005 87 627 72	Easy-Click 60 Female adapter for installation of e.g. stop valves on fume extraction units
	T005 87 627 73	Easy-Click 60 male adapter 90°
	T005 87 620 36	Extension hose, heavy construction, sold by metre (max. length 15 m)
	T005 87 627 68	Hose connection female 60 mm for flexible hose T005 87 620 36
	300-3011	Easy-Click 60 hose connection female 60 mm

Volume extraction

Tip Extraction



Laser Extraction

Accessories Volume extraction







Spare filter



Pipe system 50

	Order No.	Description
	T005 87 358 47	Hose connection 50 for WFE 2S, WFE 4S, ZS 4V and ZS 6V. For connection to Ø 50 mm (1.96 in) pipe or extraction hose
	T005 87 358 48	Hose connection 50, 90° for connection to Ø 50 mm (1.96 in) pipe or extraction hose
	T005 87 353 27	Extraction hose 50, for connection to pie system Ø 50 mm, sold by meter

Pipe system 75

	Order No.	Description
	T005 87 358 32	Hose connection 75 for ZS 4V, ZS 6V, WFE 2S und WFE 4S e.g. for connection to a stand alone system by means Ø 75 mm (2.95 in) pipe or extraction hose. Plastic, black
	T005 87 358 33	Hose connection 75, 90° for connection of Ø 75 mm (2.95 in) pipe or extraction hose, plastic, black
	T005 87 353 13	Extraction hose 75 for connection to pie system 75, flexible, sold by metre
	T005 87 358 31	Hose clamps 70-90 mm (2.75 - 3.54 in), 2 pieces, for securing extraction hose 75
 	T005 87 358 56	Adapter PEHD pipe system 75 to pipe system 50, without seals



Accessories Volume Extraction

	Order No.	Description
	800-5002	Reduction 100 / 63 mm, incl. quick connection
	T005 36 574 99N	Easy-Click 60 Stop valve for table connection of and flex arm and extraction hose including air flow valve and 2 bench mounting brackets.
	T005 36 575 99	Bench mounting brackets, 2 pcs., max. width of clamp 100 mm (3.93 in), metal
	T005 87 627 46N	Easy-Click WFV 60 A Automatic valve, including 2 bench mounting brackets, WX soldering station controlled automatic valve, male / male
	T005 87 627 65N	WFV 60 Stop valve for extraction arms without valve
	780-3001-ESDN	Hanging device for table mounting for fume extraction unit WFE 2X, MG 100, MP 140 including 2 brackets
	FT-WN	Replacement butterfly valve plate for stop valve with axis rod and handle
	T005 87 628 08	Butterfly valve for WFV 60 stop valve

Volume extraction

Tip Extraction

Laser Extraction

Accessories Volume extraction

Spare filter



Accessories Installation Volume Extraction

	Order No.	Description
	T0058762766	Easy-Click 60 T-piece with 2 male connections and 1 female connection
	T0058762774	Easy Click 60 End Cap, 60 mm connection
	T0058762771	Adapter Ø 75 mm for Easy-Click 60
	T0058762750	40/60 Adapter for Easy-Click 60 Extraction arms on Ø 50 mm WFEMP50 power socket.
	T0058762753	Hose adapter with Silicon Ring Ø 50 mm for Zero Smog 4V, Zero Smog 6V, Zero Smog EL, Zero Smog TL, WFE 2ES, WFE 2CS, WFE 2S, WFE 2S, MG or MP fume extraction units, for connection of Easy-Click 60 mm extraction hose.



Volume extraction

Tip Extraction

Laser Extraction

Accessories Volume extraction

Spare filter



Tip extraction

Weller FE (Fume Extraction) soldering irons have a smoke tube adapted to the handle. When soldering the tube is positioned directly above the tip and collects any fumes produced. Fume extraction irons can be connected to Weller FE.



WFE Fume extraction unit

WFE fume extraction unit

6 bar

LOW SOUND LEVEL < 39 db (A)



Order No. T005 36 402 99N

- Maintenance free compressed air converter
- For industrial long term use
- Up to 2 FE soldering irons can be connected
- High stability against overturning
- A compressed air cleaning filter removes additional odours caused by the compressed air.



TECHNICAL DATA

Max. capacity	2 workstations
Dimensions L x W x H (Inches)	5,51 x 5,51 x 7,87
Dimensions L x W x H (mm)	140 x 140 x 200
Weight (approx.) in kg	2.7
Noise level (distance 1 m) dB(A)	< 39
Max. blower vacuum (Pa)	20.000
Operating pressure in bar/psi	3,5 - 6,0 / 50 - 90
Air consumption l/min	30
Pre-filter	Pre filter mat class F7
Compact filter	Particle filter H13, Wide band gas filter (50 % Active carbon + 50 % Chemisorb)
ESD-safe	✓

Scope of supply	Order No.	Model	Description
		WFE Unit	WFE Unit
	T005 36 410 99	Compact filter - WFE, WFE P, WFE 2P, FT 12, FT 11, FE 4000	Compact filter - WFE, WFE P, WFE 2P, FT 12, FT11, FE 4000
	T005 36 421 99	Fine dust filter F7 for WFE, WFE P, WFE 2P, FT 11, FT 12, FE 3000/4000	Fine dust filter F7
	T005 87 357 57	Air cleaning filter WFE	Compressed air cleaning filter for WFE



WFE P Extraction unit

WFE P fume extraction unit 230 V / 50 Hz

70 W

LOW SOUND LEVEL < 45 db(A)



Order No. T005 36 386 99N

- Up to 2 FE soldering irons can be connected
- Electric vacuum pump to produce the required vacuum
- 2 power stages for higher extraction performance with 2 FE soldering irons
- Portable unit for stand alone applications (Not useable for 24 hours long term use)
- The motor is maintenance-free and has a thermal over load to protect the unit.



TECHNICAL DATA

Max. capacity	1-2 workstations
Dimensions L x W x H (Inches)	5,51 x 5,51 x 11,61
Dimensions L x W x H (mm)	140 x 140 x 295
Weight (approx.) in kg	4
Noise level (distance 1 m) dB(A)	< 45
Max. blower vacuum (Pa)	30.000
Operating pressure in bar/psi	na
Air consumption l/min	na
Pre-filter	Pre filter mat class F7
Compact filter	Particle filter H13 Wide band gas filter (50 % Active carbon + 50 % Chemisorb)
ESD-safe	✓

Scope of supply	Order No.	Model	Description
		WFE Unit	WFE Unit
	T005 36 410 99	Compact filter - WFE, WFE P, WFE 2P, FT 12, FT 11, FE 4000	Compact filter - WFE, WFE P, WFE 2P, FT 12, FT11, FE 4000
	T005 36 421 99	Fine dust filter F7 for WFE, WFE P, WFE 2P, FT 11, FT 12, FE 3000/4000	Fine dust filter F7

Volume extraction

Tip extraction

Laser extraction

Accessories volume extraction

Spare filter



Tip extraction

FT 12 Fume extraxtion unit

Fume extraxtion unit

6 bar

LOW SOUND LEVEL < 37 db (A)



Order No. 112- 00 00- ESDN

- Up to 2 FE soldering irons can be connected
- Maintenance-free compressed air converter
- Portable unit for stand alone applications for industrial long terme use
- For industrial long terme use
- A compressed air cleaning filter removes additional odours caused by the compressed air.



TECHNICAL DATA

Max. capacity	1-2 workstations
Dimensions L x W x H (Inches)	4,73 x 4,73 x 7,87
Dimensions L x W x H (mm)	120 x 120 x 200
Weight (approx.) in kg	1.7
Noise level (distance 1 m) dB(A)	< 37
Max. blower vacuum (Pa)	20.000
Operating pressure in bar/psi	3,5 - 7,0 / 50 - 100
Air consumption l/min	27
Pre-filter	Pre filter mat class F7
Compact filter	Particle filter H13, Wide band gas filter (50 % Active carbon + 50 % Chemisorb)
ESD-safe	✓

Scope of supply	Order No.	Model	Description
		FT 12 Unit	FT 12 Unit
	T005 36 410 99	Compact filter - WFE, WFE P, WFE 2P, FT 12, FT 11, FE 4000	Compact filter - WFE, WFE P, WFE 2P, FT 12, FT11, FE 4000
	T005 36 421 99	Fine dust filter F7 for WFE, WFE P, WFE 2P, FT 11, FT 12, FE 3000/4000	Fine dust filter F7



Zero Smog 20T

ZS 20T fume extraction unit 230 V / 50 Hz



Order No. T005 36 706 99N

- Up to 20 FE soldering irons can be connected
- Electric driven, maintenance free turbine produces the required vacuum
- Mobile unit for central and stand alone applications
- Central installation for 50 mm pipe systems up to 200 m (656 ft.) length possible.
- For use with pipe systems up to 200 m (7874 in)



TECHNICAL DATA

Max. capacity	1–20 workstations
Dimensions L x W x H (Inches)	17,7 x 17,7 x 27,3
Dimensions L x W x H (mm)	450 x 450 x 695
Weight (approx.) in kg	45
Voltage	230 V (50/60 Hz)
Power	530 VA
Noise level (distance 1 m) dB(A)	< 51
Max. blower vacuum (Pa)	10.000
Capacity m ³ /h	100
Pre-filter	Pre filter mat class F7
Compact filter	Particle filter H13 and wide band gas filter (50 % active carbon / 50 % Chemisorb)
ESD-safe	✓
Traceability (unit data)	✓

Scope of supply	Order No.	Model	Description
	T005 87 358 36	Fine dust filter F7	Fine dust filter F7 for Zero Smog 20T, WFE 20D, WFE 4S, Zero Smog 6V, FC 800
	T005 87 358 38	Compact filter	Compact filter for WFE 20D, WFE 4S, Zero Smog 6V, Zero Smog 20T, FC 800

Volume extraction

Tip extraction

Laser extraction

Accessories volume extraction

Spare filter



Accessories Tip Extraction

FE 75 Set



Soldering iron FE 75 with safety rest

80 W Silver Line

Order No. T005 33 151 99N

- For tip extraction
- For use with LT tips



Scope of supply	Order No.	Model	Description
	T005 15 020 99	KH 20	Safety Rest for FE 75, TCPS, W 101, LR 21
	T005 29 166 99N	FE 75	Soldering iron FE 75
	T005 44 405 99	LT B	Soldering tip, chisel, Ø 2,4 x 0,8 mm
Accessories	Order No.	Model	Description
	T005 87 447 10N	Barrel for WSP 80 spare part	Barrel for WSP 80 spare part

FE 75 Attachment

	Order No.	Description
 	T005 25 125 99N	Fume extraction accessory set for LR 21, LR 82, TCPS, W 61, W 101, WSP 150, WP 200, WXP 200 only with safety rest AK 1
	T005 28 126 99N	FE Attachment for WSF 80D5/D8 with AKS safety rest
 	T005 13 125 99N	FE Attachment for DS 22, DS 80 and DSX 80 desoldering irons



Universal FE Attachments

	Order No.	Description
	T005 29 186 99N	FE Attachment with tube, Ø 6,5 mm for WMP, WSP 80, WP 80, MLR 21, WP 120
	T005 29 214 99N	FE Attachment with tube Ø 6,5 mm for WXP 65/WP 65 and WXP 120/WP 120 soldering irons
	T005 29 185 99N	FE Attachment with tube, Ø 4,5 mm, for WP 80, WSP 80, WMP, WMRP/WXMP, MLR 80
	T005 87 448 75	FE-Clip-Set for FE-attachment Ø 4,5 mm
		
	T005 87 448 76	FE-Clip-Set for FE attachment Ø 6,0 mm
		
	T005 87 657 98N	FE-Add-on kit, attachment tube Ø 6,5 mm for WXP 120 soldering iron
	T005 87 657 99N	FE-Add-on kit, attachment tube Ø 6,5 mm for WXP 65 soldering iron

Volume extraction

Tip extraction

Laser extraction

Accessories volume extraction

Spare filter



Tip Extraction Accessories

Order No.	Description
001-0044-ESDN	Clip-on kit universal (model 4), für ERSA Micro-Tool
001-0051-ESD	Clip-on kit for ERSA Micro tool
001-0093N	Clip-on kit Weller WSP 80, MRL21, MT1500, Hakko 807/912
010-2825-ESDN	Spot suction nozzle for clip-on kit, Metcal/Universal 1, Length: 200 mm; Ø 5,0 / 4,6 mm (Length: 7,874; Ø 0,197 / 0,181 in)
010-2827-ESDN	Spot suction nozzle for clip-on kit, ERSA Micro tool, Length: 140 mm; Ø 5,0 / 4,6 mm (Length: 5,512; Ø 0,197 / 0,181 in)
010-2828-ESDN	Spot suction nozzle for clip-on kit, Filtronic universal 2 & 3, Length: 220 mm; Ø 5,0 / 4,6 mm (Length: 8,661; Ø 0,197 / 0,181 in)
010-2833-ESD	Spot suction nozzle for clip-on kit, Pace PS80/SP2A, Length: 220 mm; Ø 4,5 / 3,9 mm (Length: 8,661; Ø 0,177 / 0,154 in)
010-2834-ESD	Spot suction nozzle for clip-on kit, Weller WSP80, MLR21, MT1500, Hakko 907/912, Length: 180 mm; Ø 6,3 / 5,4 mm (Length: 7,087; Ø 0,248 / 0,213 in)
001-0014	E-clips 4/6 mm (0,026 in)
010-1041	Conductive silicone hose Ø 7 / 4,5 mm (0,276 / 0,177 in), by meter
010-1042N	Conductive silicone hose Ø 8 / 5 mm (0,315 / 0,197 in), by meter
010-9901-ESD	Cleaning brush, 4 mm (0,157 in)
010-9902-ESD	Cleaning brush, 5 mm (0,197 in)

Locking clip for extraction hose

Order No.	Description
T005 36 352 99	Locking clip for extraction hose
T005 25 410 00	Extraction hose (spare), Ø 5 mm, by meter





Accessories for workbench installations

	Order No.	Description
	T005 36 316 99	Extraction hose complete with 2 connecting elements for direct connection of Zero Smog 20T (WFE 20D) to pipe system 50
	T005 36 414 00	Extraction hose without connecting elements, sold by metre
	T005 36 415 99	Connection Element 40-50 for connecting extraction hose 40 and pipe system 50
	T005 36 326 99	Extension hose DN 17, 5 m
	T005 87 358 65	Connection nipple on extension hose DN 17 / G 3/8" (T0053632699)
	T005 36 338 99	Connection nipple for extraction hose Ø 5 mm / 0.19 in, for connection with FE soldering irons to nossle 50
	T005 87 350 50	End cap for connection nipple Ø 5 mm (T0053633899)
	T055 87 628 10	Connection adapter for Zero Smog 20T

Volume extraction

Tip extraction







Laser extraction

Accessories volume extraction



Spare filter



Accessories Tip Extraction

	Order No.	Description
	T005 15 086 99N	Basic Unit pneumatic (for WFE, WFE P) Stop+Go + Safety Rest with Fibre Optic Sensor for FE 75
	T005 15 076 99N	Basic Unit Electric (for WFE, WFE P) Stop+Go + Safety Rest Function with Fibre Optic Sensor for FE 75
	T005 15 080 99N	Second Safety Rest with Fibre Optic Sensor for Extending to 2 Workplaces for FE 75
	T005 15 168 99N	Basic unit electric (for WFE) safety rest with Stop+Go function with fibre optic sensor for WSP 80, WP 80, WP 120
	T005 15 167 99N	Basic unit electric (for WFE P) safety rest with Stop+Go function for soldering irons WSP 80, WP 80, WP 120 with fibre optic sensor.
	T005 15 161 72N	WDH 10T OPTO Second safety rest for KHE / KHP with fibre optic sensor for extending to 2 workplaces
	T005 15 152 99N	Safety rest with dry cleaner

Cord Support

	Order No.	Description
 	T005 15 066 99	Cord support for safety rest KH 20/23



Volume extraction

Tip extraction

Laser extraction

Accessories volume extraction

Spare filter



Laser extraction

Weller offers with its Laserline series mobile fume extractions for all kinds of laser applications. All systems are retrofittable with special filters for cleanroom or for the use of inkjet printers. Weller Laserline filter systems have one more crucial advantage. they are the quietest in the world.

Laser Line LL 150

Laser extraction unit, 100- 240 V / 60 Hz

175 VA

LOW SOUND LEVEL  < 50 db(A)



Order No. FT-L 15 N

- Remote control via RS 232 port
- Efficient laser extraction unit for low dust amount
- Optical and acoustic filter full alarm
- Switch power supply 100 - 240 V
- 3 levels of filtering



TECHNICAL DATA

Dimensions L x W x H (Inches)	13,4 x 13,4 x 24,01
Dimensions L x W x H (mm)	340 x 340 x 640
Weight	18 kg
Voltage	100 - 240 V, 60 Hz
Power	175 VA
Noise level (distance 1 m) dB(A)	< 50 dB (A)
Max. vacuum	2300 Pa
Capacity l/min	140 m ³ / h
Maximum extraction power with standard filter, m3/h (CFM)	100 (58,8)
EPA class microfilter, degree of separation, MPPS %	> 99,95
Active carbon gas filter chemisorption, degree of separation, %	> 99,96
Pre-filter (class, size m2)	F8 / 0,24

Scope of supply	Order No.	Model	Description
		Laser Line 150 Unit	Laser Fume Extraction Unit 150
	150-2012-LN	Micro/Gasfilter Laser Line 150	Micro/Gasfilter Laser Line 150. Particle filter H13, Wide band gas filter (50 % active carbon + 50 % Chemisorb)
	150-4000	Pre-filter F7 Laser Line 150	Pre-filter F7 Laser Line 150



Laser Line LL 200V

Laser extraction unit, 230V / 50 Hz

200 VA  **< 52 db(A)** 

Order No. FT91 00 169 9N

- For Laser marking, engraving, and welding applications with low up to mid dust volumes.
- The Constant flow control (CFC) guarantees a automatical air flow regulation independent of the filter polution rate.
- Efficiency test via USB port
- Acoustical and optical filter alarm
- Low noise level

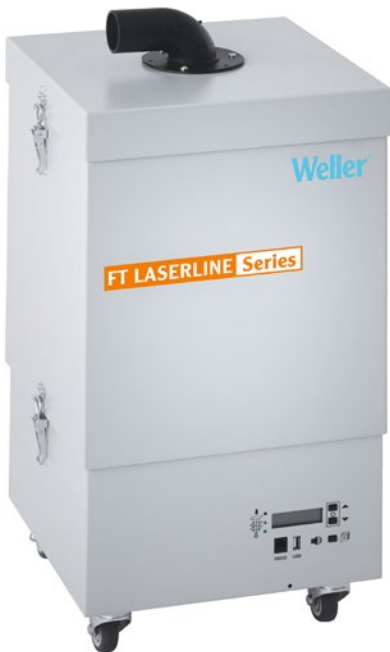

TECHNICAL DATA

Dimensions L x W x H (Inches)	12,59 x 12,59 x 27,55
Dimensions L x W x H (mm)	320 x 320 x 700
Weight	21 kg
Voltage	230 V, 50/60 Hz
Power	200 VA
Noise level (distance 1 m) dB(A)	< 52 dB (A)
Max. vacuum	3800 Pa
Capacity l/min	230 m ³ / h
Maximum extraction power with standard filter, m3/h (CFM)	160 (95)
EPA class microfilter, degree of separation, MPPS %	> 99,95
Active carbon gas filter chemisorption, degree of separation, %	> 99,96
Pre-filter (class, size m2)	F7 / 0,45

Scope of supply	Order No.	Model	Description
		Laser Line 200V Unit	Laser Fume Extraction 200V Unit
	FT910 00 007	Pocket filter F7 0,5 m ² Laser Line 200V	Pocket filter F 7 Filter Surface 0, 5 m ² for Laser Line 200V
	FT910 00 008 N	Compact filter for Laser Line 200 V	Particle filter H13 and Wide band gas filter

Volume extraction

Tip extraction

Laser extraction

Accessories volume extraction

Spare filter



Laser Line LL 400V

Laser extraction unit, 230V / 50 Hz

460 VA **LOW SOUND LEVEL** **< 53 dB(A)**

Order No. FT91 00 269 9N

- The Constant flow control (CFC) guarantees a optimal air flow regulation independent of the filter pollution rate.
- Efficiency test via USB port
- Electronic filter control with optical and acoustical filter alarm
- Laser extraction unit for laser marking, grinding, cutting, welding with high dust amount.



TECHNICAL DATA

Dimensions L x W x H (Inches)	17,4 x 17,4 x 40,1
Dimensions L x W x H (mm)	441 x 441 x 1020
Weight	51 kg
Voltage	230 V, 50/60 Hz
Power	460 VA
Noise level (distance 1 m) dB(A)	< 53 dB (A)
Max. vacuum	3000 Pa
Capacity l/min	645 m ³ / h
Maximum extraction power with standard filter, m3/h (CFM)	400 (235)
EPA class microfilter, degree of separation, MPPS %	> 99,95
Active carbon gas filter chemisorption, degree of separation, %	> 99,96
Pre-filter (class, size m2)	F7 / 2,0

Scope of supply	Order No.	Model	Description
		Laser Line 400V Unit	Laser Line 400V Unit
	FT910 00 006	Pocket filter F7 2,5 m ² Laser Line 400V	Pocket filter F 7 Filter Surface 2,5 m ² for Laser Line 400V
	FT910 00 010	Compact Filter Laser Line 400V	Particle filter H13 and Wide band gas filter



Accessories

Exhaust accessories to blow waste air out of a building



Order No.	Description
T005 87 358 40	Exhaust connector DN 100 for Zero Smog 6V and WFE 4S
T0058735920	Exhaust connector of pipe 100 to fume extraction unit WFE 20D, ZS 20 T
T005 87 359 15	Exhaust connector DN 75 for WFE 2S, Zero Smog 4V, WFE 4S and Zero Smog 6V

Remote control for fume extraction units

Order No.	Description	Order No.	Description
 T005 87 359 09N	Remote control for fume extraction units ZS 4V, ZS 6V, ZS 20T with filter status display	 T005 87 647 12	WX Adapter for WFE/WHP
 T005 31 191 99	Interface cable RS 232, 2 m (78.74 in) for remote control or monitoring by PC (type 1:1)	 T005 87 647 10	WX Connecting cable, 2 m
 700-3057	Remote control for fume extraction unit WFE 2X, MG 100, MG 200, MG 400 with 2 m (78.74 in) cable	 T005 87 647 26N	WX HUB
 T005 87 627 24	WX Adapter is needed for connection of the remote control (T0058735909) to Zero Smog 4V, 6V, 20T	 T005 87 687 67	WT HUB

Volume extraction

Tip extraction

Laser extraction

Accessories volume extraction

Spare filter



Spare Filters

Zero Smog 2, MG 130, MG 140 ,
Zero Smog 4V, Zero Smog 6V,
Zero Smog 20T,
Zero Smog TL, Zero Smog EL

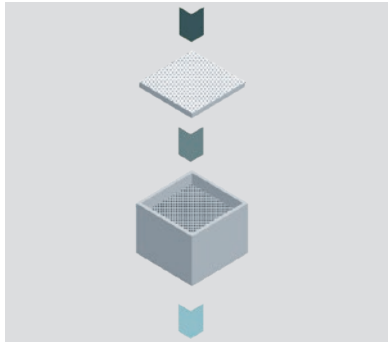

MG 100S

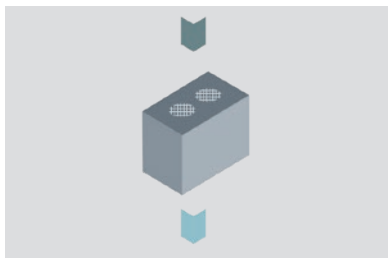

FT 12, WFE P

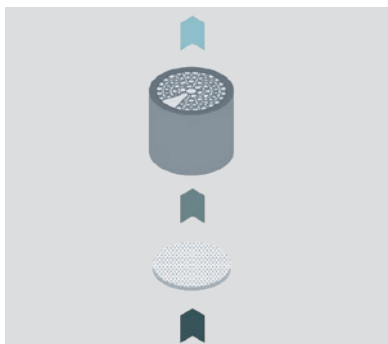

Filter



Zero Smog TL	FT91013699	
Zero Smog EL		
MG 130	100-240 V: 130-1000-ESD	
MG 100S	230 V: 100-1000-ESD	120 V (USA): U-100-1000-ESD
MG 140	230 V: 145-1000-ESD	230 V: mit 145-1002-ESD
Zero Smog 4V	230 V: T005 36 606 99	100-120 V (USA): T005 36 602 99
Zero Smog 4V gas filter	230 V: T005 36 616 99	100-120 V (USA): T005 36 612 99
Zero Smog 6V	230 V: T005 36 666 99	100-120 V (USA): T005 36 662 99
Zero Smog 6V	230 V: T005 36 676 99	100-120 V (USA): T005 36 672 99
WFE		
WFEP	230 V: T005 36 386 99	120 V, WFE2P (USA): T005 36 232 99
FT 12		
Zero Smog 20T	230 V: T005 36 706 99	120 V (USA): T005 36 702 99
Pocket filter ZS6V/4V	T005 87 358 62	

Special filter

MG 100S	230 V: 100-1000-ESD	120 V (USA): U-100-1000-ESD
MG 140	230 V: 145-1000-ESD	230 V: mit 145-1002-ESD
Zero Smog 4V	230 V: T005 36 606 99	100-120 V (USA): T005 36 602 99
Zero Smog 6V	230 V: T005 36 666 99	100-120 V (USA): T005 36 662 99
WFE		
WFEP	230 V: T005 36 386 99	120 V, WFE2P (USA): T005 36 232 99
FT 12		



Filter Matrix

	Medium dust filter M5	Fine dust filter F7				Compact filter H13				Adhesive fumes filter	Pocket filter		
	T005 87 358 37 10 pcs.												
	T005 87 359 37 10 pcs.												
	T005 87 627 03 10 pcs.	✓											
	130-2010 5 pcs.		✓										
	145-4000 2 pcs.			✓									
	T005 36 421 99 3 pcs.				✓	✓	✓	✓					
	T005 87 358 36 10 pcs.	✓	✓	✓									
	T005 87 359 38 10 pcs.			✓	✓								
	T005 87 358 60 1 pcs.	✓											
	210-0313 10 pcs.				✓	✓	✓	✓					
	T005 87 628 57 10 pcs.												
	T005 87 628 58												
	T005 87 627 01												
	130-2000-ESD								✓				
	100-2000-ESD									✓			
	T005 36 410 99										✓		
	T005 87 358 38									✓	✓		
	T005 87 359 36											✓	
	145-2000-ESD											✓	
	T005 87 358 35									✓	✓		
	T005 87 358 95											✓	
	T005 87 359 24											✓	
MEK		Solvents				Cleanroom class 5				Adhesive fumes			
	145-2003-ESD												
	100-2003-ESD	✓											
	100-2012-ESD	✓											
	145-2012-ESD	✓											
	100-2002-ESD	✓											
	145-2002-ESD	✓											
	FT91000019												
	T005 87 358 95												
	T005 36 407 99												
	T005 87 358 35												

Volume extraction

Tip extraction

Laser extraction

Accessories volume extraction

Spare filter



Before using special filters please check in the MSD data sheet if they are suitable for your application, or simply contact your local Weller representative for further support.



Weller Zero-Smog® systems

Specifically designed for continuous operation in industrial environments. Care and attention at the design stage plus careful component choice and a high quality manufacturing process have given Weller extraction systems a world wide reputation for reliability and longevity.

Weller Zero-Smog® fume extraction

Weller Zero-Smog® systems have a three stage filter system (excl. MG 100S) for removing small particles, fumes and gases that are produced in different working processes:

The hazardous substances are efficiently captured by the nozzle and are absorbed into the filter.

Bigger particles get caught in the pre-filter and smaller particles get caught in the HEPA (High Efficiency Particulate Air) filter.

The wide band gas filter removes fumes and adhesives.

End product – clean air – is re-circulated into the workplace.

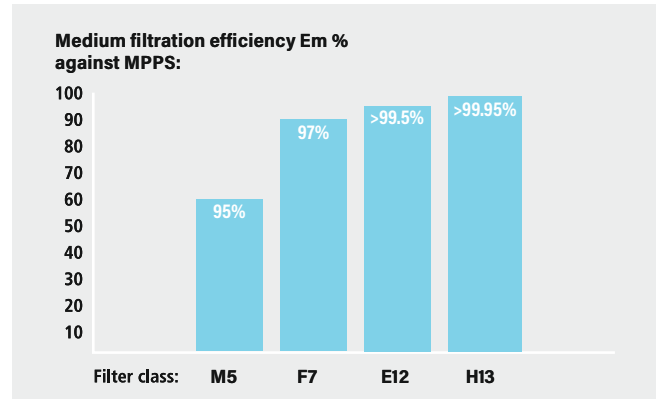
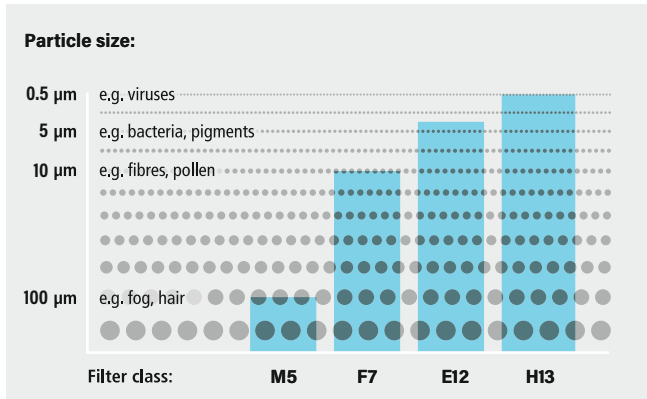

Filter Class M5, F7: Fine dust filter as per EN 779:2012

Filter Class E12/H13: According EN 1822:2009 HEPA (High Efficiency Particulate Air) Filter

Filter classification according EN norm EN 1822:2009

Filter Class	Recommended Application
M5	For standard applications
F7	For applications with high flux or dust content
E12 / H13	For applications with high flux or dust content
Gas	For applications with fumes from adhesives and solvents

Group	Filter class	Integral value	
		Degree of separation	Transmittance degree
EPA	E10	85 %	15 %
	E11	95 %	5 %
	E12	99,5 %	0,5 %
HEPA	H13	99,95 %	0,05 %
	H14	99,995 %	0,005 %

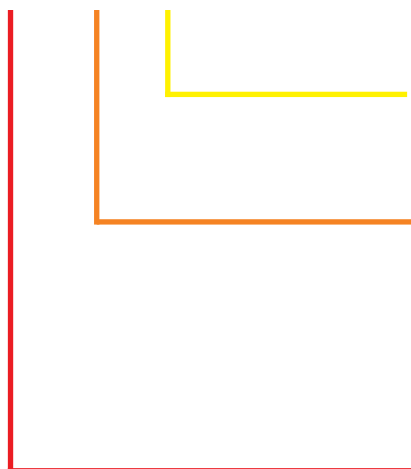

1. Medium / fine dust filter

For standard applications with a small amount of flux and pollution gases with high solid content, Weller offers filter classes M5 or F7

2. Compact filter consisting of:

Particle filter H13 with deposition performance according EN 1822:2009

> 99.955% in MPPS (particles 0.16 µm)

> 99.994% particles 0.3 µm

Wide band gas filter. For cleaning harmful fumes and vapours. The Weller wide band gas filter consists of 50% active carbon and 50% Chemisorb (potassium permanganate).

Harmful gases with a high molecular weight are cleaned by the active carbon. Chemisorb is suitable for absorbing gases of lower molecular weight. Because of its composition, Chemisorb is able to convert a large number of chemical pollutants (e.g. formaldehyde) into non-polluting gases by means of molecular modification.

3. Gas filter (optional)

The gas filter is used for extracting adhesive fumes and solvents. Experience has shown that filtering suspended particles is not so vital in this respect. The gas filter is filled with 50% active carbon and 50% Chemisorb. The particle filter is omitted.



Spare Filters

Compressed air cleaning filter for WFE, FT 12, FT 12-PF

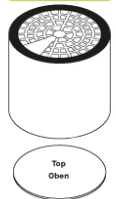

Order No.	Description	Filter type	PU
T005 87 357 57	Compressed air cleaning filter for WFE	Active carbon 100%	1
210-0323-ESD	Compressed air cleaning filters for FT 1 / FT 12 / FT 13	Active carbon 100%	1

Compact filter - WFE, WFE P, WFE 2P, FT 12, FT11, FE 4000



Order No.	Description	Filter type	PU
T005 36 410 99	Compact filter - WFE, WFE P, WFE 2P, FT 12, FT11, FE 4000	Compact filter: Particle filter H13 and Wide band gas filter (50 % active carbon + 50 % Chemisorb)	1

Compact filters for glueing applications WFE, WFE P, WFE 2P, FT 12, FT 11, FE 4000

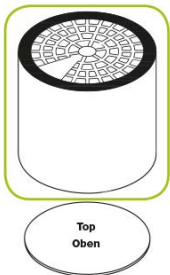

Order No.	Description	Filter type	PU
T005 36 407 99	Compact filters for glueing applications WFE, WFE P, WFE 2P, FT 12, FT 11, FE 4000	Compact filter H13, wide band gas filter 100 % active carbon	1

Volume extraction

Tip extraction

Laser extraction

Accessories volume extraction

Spare filter



Compressed air cleaning filter for WFE, WFE P, WFE2P, FT 11, FT 12, FT 12-PF, FE 3000/4000



Order No.	Description	Filter type	PU
T005 36 421 99	Fine dust filter F7	Fine dust filter F7	3

Compressed air cleaning filters for WFE, WFE P, WFE2P, FT 12, FT 12-PF

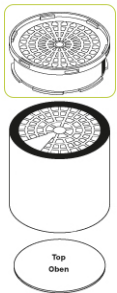

Order No.	Description	Filter type	PU
210-0323-ESD	Compressed air cleaning filters for FT 1 / FT 12 / FT 13	Active carbon 100%	1
210-0315	Filter discs FT 1 (pink)		10

Medium dust filters M5

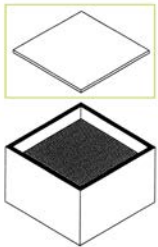

Order No.	Description	Filter type	PU
T005 87 358 37	Fine dust filters M5 for Zero Smog 20T, WFE 20D, WFE 4S, Zero Smog 6V, FC 800	Fine dust filter M5	10
T005 87 359 37	Fine dust filter for WFE 2S, Zero Smog 4V	Fine dust filter M5	10

Fine dust filters F7

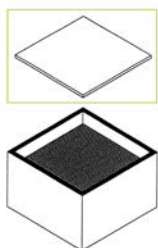

Order No.	Description	Filter type	PU
T005 87 358 36	Fine dust filter F7 for Zero Smog 20T, WFE 20D, WFE 4S, Zero Smog 6V, FC 800	Fine dust filter F7	10
T005 87 359 38	Fine dust filter F7 for WFE 2S, Zero Smog 4V	Fine dust filter F7	10
T005 87 628 57	Fine dust filter F7 for Zero Smog TL	Fine dust filter F7	10



Compact filters

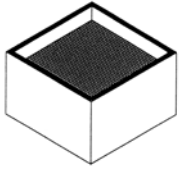

Order No.	Description	Filter type	PU
T005 87 358 38	Compact filter for WFE 20D, WFE 4S, Zero Smog 6V, Zero Smog 20T, FC 800	Compact filter: Particle filter H13 and wide band gas filter (50% active carbon, 50% Chemisorb)	1
T005 87 359 36N	Compact filter: Particle filter H13 and wide band gas filter (50% active carbon, 50% Chemisorb) for Zero Smog 4V, WFE 2S	Particle filter H13 and wide band gas filter (50% active carbon, 50% Chemisorb)	1
T005 87 627 01	Compact filter: particle filter H13 and granular activated carbon filter with 10 pre-filters M5 for Zero Smog 2, Zero Smog EL, WFE 2ES / CS	Aktivkohlegranulat	1
T005 87 628 58	Filter Set: Compact filter particle filter H13 and granular activated carbon filter with 10 F7 pre-filters for the Zero Smog TL	Particle filter H13 and wide band gas filter	1

Adhesive fume filters

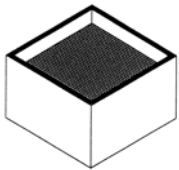

Order No.	Description	Filter type	PU
T005 87 358 35	Wide band gas filter for Zero Smog 6V, WFE 4S	Wide band gas filter (50 % active carbon + 50 % Chemisorb)	1
T005 87 358 95N	Wide band gas filter for adhesive fumes for Zero Smog 4V, WFE 2ES, WFE 2S	Wide band gas filter (50 % active carbon + 50 % Chemisorb)	1

Pocket filter



Order No.	Description	Filter type	PU
T005 87 358 60	Pocket filter F7 for Zero Smog 4S, Zero Smog 6V, WFE 2S / WFE 4S	Pocket filter F7	1

Pocket filter

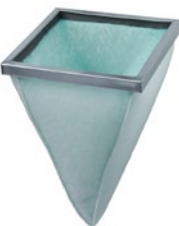

Order No.	Description	Filter type	PU
T005 87 359 24	Fleece filter for Zero Smorg 4V, Zero Smog 6V, WFE 2S / WFE 4S		1

Volume extraction

Tip extraction

Laser extraction

Accessories volume extraction

Spare filter



Compact filters MG 140

Compact filters for MG 140



Order No.	Description	Filter type	PU
145-2000-ESDN	Particle filter H13 and wide band gas filter, Standard	Particle filter H13, Wide band gas filter (50 % active carbon + 50 % Chemisorb)	1
145-2002-ESDN	Particle filter H13 and wide band gas filter, Cleanroom	Particle filter H13, Wide band gas filter (50 % Active carbon + 50 % Chemisorb)	1
145-2012-ESDN	Compact filter: Particle filter H13 and wide band gas filter, Solvents / VOC	Particle filter H13, wide band gas filter (100 % active carbon)	1
145-2003-ESDN	Compact filter: Particle filter H13 and wide band gas filter, MEK	Particle filter H13, wide band gas filter (100 % Chemisorb)	1

Compact filter for MG 100, MG 100S, MG 80S, WFE 2X



Order No.	Description	Filter type	PU
100-2000-ESDN	Particle filter H13 and wide band gas filter, Standard	Particle filter H13, Wide band gas filter (50 % active carbon + 50 % Chemisorb)	1
100-2012-ESDN	Compact filter: Particle filter H13 and wide band gas filter, Solvent / VOC, for MG 100, MG 100S, WFE 2X	Particle filter H13, wide band gas filter (100 % active carbon)	1
100-2003-ESDN	Compact filter for MG 100 / MG 100S / MG 80S / WFE 2X: Particle filter H13 and wide band gas filter, MEK	Particle filter H13, wide band gas filter (100 % Chemisorb)	1

Compact filter for MG130



Order No.	Description	Filter type	PU
130-2000-ESDN	Particle filter H13 and wide band gas filter, Standard	Particle filter H13, Wide band gas filter (50 % active carbon + 50 % Chemisorb)	1



Compact filters for MG 200, MG 400



Order No.	Description	Filter type	PU
200-2000-ESDN	Compact filter MG 200 Standard	Particle filter H13, Wide band gas filter (50 % active carbon + 50 % Chemisorb)	2
200-2002-ESDN	Particle filter H13 and wide band gas filter, cleanroom	Particle filter H13, Wide band gas filter (50 % Active carbon + 50 % Chemisorb)	2
200-2003-ESDN	Compact filter for MG 200, MEK	Particle filter H13, wide band gas filter (100 % Chemisorb)	2

Prefilter for MG 140

Order No.	Description	Filter type	PU
140-2000-ESDN	Particle filter E 12	Particle filter	1
145-4000	Pre-filter for MG 140 / F8 (2 pieces)	Fine dust filter	2

Prefilter for MG 140, MG100



Order No.	Description	Filter type	PU
PF-100 0	Pre filter box, incl. brackets and 2 m connection hose		1
500-4000	Pre-filter for PF-1000, BT 75	Fine dust filter	5

Compressed air cleaning filters for WFE, WFE P, WFE2P, FT 12, FT 12-PF



Order No.	Description	Filter type	PU
210-0323-ESD	Compressed air cleaning filters for FT 1 / FT 12 / FT 13	Active carbon 100%	1
T005 36 421 99	Fine dust filter F7	Fine dust filter F7	3

Volume extraction

Tip extraction

Laser extraction

Accessories volume extraction

Spare filter



Replacement filters for discontinued MG filter systems

Compact filter for MG 75

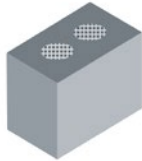

Order No.	Description	Filter type	PU
750-2002-ESDN	Particle filter H13 and gas filter, Cleanroom	Particle filter H13 , Wide band gas filter (50 % active carbon + 50 % Chemisorb)	1
750-2003-ESDN	Particle filter H13 and gas filter, MEK	Particle filter H13, wide band gas filter (100 % Chemisorb)	1

Compact filter for MG 95

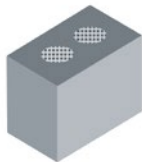

Order No.	Description	Filter type	PU
950-2000-ESDN	Particle filter H13 and gas filter, Standard	Particle filter H13 , Wide band gas filter (50 % active carbon + 50 % Chemisorb)	1
950-2002-ESDN	Particle filter H13 and gas filter, Cleanroom	Particle filter H13 , Wide band gas filter (50 % active carbon + 50 % Chemisorb)	1
950-2003-ESDN	Particle filter H13 and gas filter, MEK	Particle filter H13, wide band gas filter (100 % Chemisorb)	1

Pre-filter for PF-1000, BT 75

Order No.	Description	Filter type	PU
500-4000	Pre-filter for PF-1000, BT 75	Fine dust filter	5